



**CRANE
TECHNOLOGIES**

Giraffe is a unique partner
on the market of construction engineering.

over
75%

of tower cranes
manufactured in Russia
are of Giraffe make.

We are distinguished by wide sales geography, perfect customer service and reliability of our product.

Continuous quality improvement and proven customer service are reasons for long-term relationships we enjoy with our customers. Improved control systems, easy operation in any conditions, mobility and efficiency make our equipment an ideal construction tool.

We put our knowledge, talent and innovative approach to create ideal construction tool which is trusted all over the world.

GIRAFFE cranes are built for comfortable and safe work –
our customers can easily reach any heights.



Improving technologies and modernizing production process Giraffe reaches reliable and robust constructions which are easy and mobile in operation.

Giraffe cranes meet the requirements of modern building industry due to unique materials, modular design and advanced engineering.

As a full-cycle company we control our products on all the stages: design, production, sales and after-sales service. An integrated approach to service allows us to create products that completely satisfy all customers' requirements.

We will never stop on our path to perfection, therefore, every day our engineers, constructors, manufacturers, sales and service staff work for your welfare and comfort.

We will never stop on our path to perfection,
therefore, every day our engineers,
constructors, manufacturers, sales and service
staff work for your welfare and comfort.

top-seller
on the tower crane
market

2014-2015

The perfect building cranes project is operated by 3 engineering centres in Europe:



AUSTRIA

3D and 2D modelling of cranes, full complex of dynamic and statistical calculations



GERMANY

crane control system solutions



RUSSIA

design and translation of documents into Unified system for design documentation

Complex approach to machine design gives a number of undeniable advantages:

- Access to the latest technical innovations in tower crane building
- High operating characteristics (operating speed, height of freestanding, perfect control system)
- The highest level of crane safety (certification system TÜV)



1747

Nyazepetrovsk Ironworks was established

Giraffe has a centuries-old history and builds up experience of generations.

Its history began in 1747.

The ironworks was established in the cradle of Russian metallurgy. For more than two centuries the company provides high-quality production that meets the actual requirements.

The modern stage of crane building has begun since 1949.

Constant drive to perfection and client-oriented cooperation has led the company to set new industry records repeatedly.

Today Giraffe is one of the biggest tower crane manufacturers in Eastern Europe, which offers perfect building equipment and first-class service to its clients.

Special attention to the quality of components and reliability of supplier lets us produce safe modern tower cranes, suitable for operation in harsh conditions.

All materials and components that we use (metal constructions, reduction gears, electric motors, slewing rings and electric equipment) are **designed for operation in harsh conditions** – from heavy snows of Siberia to flaming sun of Baku.

Full-fabricated construction of all tower sections guarantees safety and durability of machines.

The achieved results of earthquake resistance afford to use tower cranes **in regions with shocks rated in 8 - 9 on earthquake magnitude on the Richter scale.**

We produce tower cranes, on which you can rely.





Giraffe takes highly individual approach to every client.

Giraffe is about help and support on all the stages of project realization.

From many different designs and versions, we will find an ideal tool to meet all your requirements.

We are always ready to cooperate with you; we offer various financial tools, among which you can easily find the one that suits you best. Broad experience of our engineering office lets us solve any kind of issues at the earliest possible date.

With the help of Giraffe you can forget about minor issues: we are always ready to take care of delivery organization, shipping, assembling and teaching your employees to work with our control and safety system.

By caring about our clients we turn high-quality steel and perfect components into an ideal building tool, which has already been highly rated in many countries.



WE ARE ALWAYS READY TO OFFER YOU THE FOLLOWING SERVICES:



- Installation and contract supervision
- Setting and maintenance of equipmen
- Equipment service and repair maintenance



- Additional options on the operator's cabin
- Individual crane coloring



- Efficient and quick solution of all operational issues
- Efficient and quick delivery



- Leasing of our lifting equipment
- Individual payment conditions



- Remote diagnostics and control system management



- Training to work with intelligent safety system

WARRANTY

We are confident of our products' quality. Therefore **the warranty period for our tower cranes is 18 months** from the date of commissioning. On client's request the warranty period can be extended to 3 years.

a maximum warranty period on client request

3 years





Giraffe is about universal solutions for building at any scope.

We clearly understand that buying a new crane is not always an option that's why we are ready to offer you our leasing services. You can take advantage from the quality of our equipment and high level of service as long as you need, and we will take care of it.

Broad experiences in the sphere of lifting equipment production as well as special attention to the client's requirements have helped us to create the nearly perfect relationship system with a client.

Renting of Giraffe cranes, first of all, is about confidence!

Confidence in supplier's reliability, equipment's quality and personnel's qualification. By trusting us, you can be confident of receiving detailed information about possibilities and features of tower cranes operation, qualified assistance in selection and efficient feedback to your questions.



Giraffe offers a wide range of services, providing maximal comfort and convenience for collaboration:



- Delivery and removal of equipment from your building unit
- Installation and dismantling of rented crane at the earliest possible date
- Provision of high-qualified crane-operators services



- Registration of tower cranes in organs of Federal Service of Environmental, Technological and Nuclear Supervision
- Development of projects for carrying out work by cranes and the foundation project of tower crane



- Equipment maintenance
- Efficient change of spare parts
- Consultation and instructional advice about installation, setting and operation of tower cranes with the variable-frequency drive systems.



Our main aim is to prove an uninterrupted tower crane operation at any units and at any place of world!

TOP-SLEWING FLAT-TOP TOWER CRANES:



Supporting frame



Anchoring foundation



Tower ties to building



Rail travelling undercarriage

Top-slewing flat-top tower cranes are the recent development in the lifting equipment market. Static tower and full-slewing jib of that tower crane helps to use not only the anchoring foundation, but also fastening of the tower crane to the building unit, thereby the height of the building construction can reach 240 m.

Flat-top construction of the crane enables to install several tower cranes on the building site with minimal height difference.



TOP-SLEWING TOWER CRANE

TDK-8.180 LT

Maximal lifting capacity, t	8
Maximal jib radius, m	60
Lifting capacity at maximal jib radius, t	1,82
Freestanding maximal lifting height, m	61
Maximal height by fastening to building, m	240



TOP-SLEWING TOWER CRANE

TDK-8.180

Maximal lifting capacity, t	8
Maximal jib radius, m	60
Lifting capacity at maximal jib radius, t	1,82
Freestanding maximal lifting height, m	61
Maximal height by fastening to building, m	240



TOP-SLEWING TOWER CRANE

TDK-10.180

Maximal lifting capacity, t	10
Maximal jib radius, m	60
Lifting capacity at maximal jib radius, t	1,80
Freestanding maximal lifting height, m	65
Maximal height by fastening to building, m	180



TOP-SLEWING TOWER CRANE

TDK-10.215

Maximal lifting capacity, t	10
Maximal jib radius, m	65
Lifting capacity at maximal jib radius, t	2,2
Freestanding maximal lifting height, m	74,9
Maximal height by fastening to building, m	240



TOP-SLEWING TOWER CRANE

TDK-12.300

Maximal lifting capacity, t	12
Maximal jib radius, m	70
Lifting capacity at maximal jib radius, t	3
Freestanding maximal lifting height, m	65
Maximal height by fastening to building, m	240

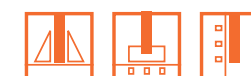

CAT-HEAD TOWER CRANES WITH SLEWING TOWER:

Cat-head tower cranes with slewing tower are the **classical building machines** ntested for decades. Due to its lifting characteristics and comfortable operation crane SMK-10.200 won popularity by building of panel houses and units of industrial usage.



Supporting frame



Rail travelling undercarriage



Rail-travelling gantry



CAT-HEAD TOWER CRANE
SMK-10.200

Maximal lifting capacity, t	10
Maximal jib radius, m	40
Lifting capacity at maximal jib radius, t	3
Freestanding maximal lifting height, m	54
Maximal lifting height with inclined jib, m	72,7



CAT-HEAD TOWER CRANE
SMK-10.180

Maximal lifting capacity, t	10
Maximal jib radius, m	30
Lifting capacity at maximal jib radius, t	5
Freestanding maximal lifting height, m	42,8
Maximal lifting height with inclined jib, m	56,5



FAST SELF-ERECTING CRANE:

Fast self-erecting crane SMK-5.66 is the unique project of Giraffe engineering centre.

Compact, mobile and efficient tower crane (you don't need specially prepared foundation for its installation), ideally fits both low-rise building, and first phase of high-rise building.

Installation, dismantling and control of tower crane SMK-5.66 is implemented from the ground with the help of remote controller and doesn't need the creation of own erection crew and allowance for overhead works.

Simplicity and convenience of construction shortens the time of installation up to 4 hours, and the usage of semi-trailer makes the crane's transport comfortable and economical.

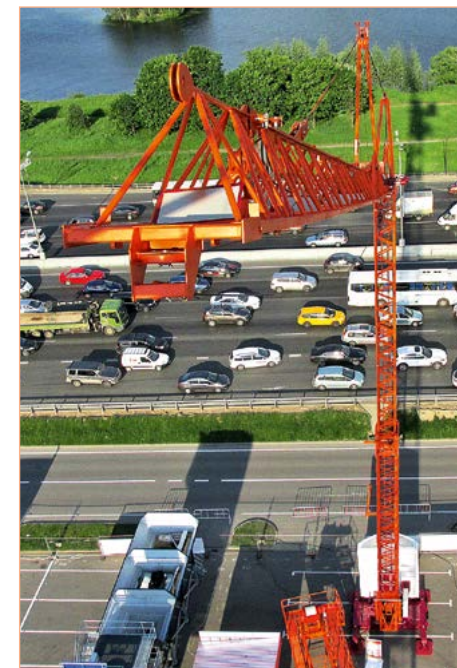

FAST SELF-ERECTING CRANE
SMK-5.66

Maximal lifting capacity, t	5
Maximal jib radius, m	43
Lifting capacity at maximal jib radius, t	1,05
Freestanding maximal lifting height, m	27
Maximal lifting height with inclined jib, m	41,7



PORTAL CRANE:



Rail-travelling gantry

Portal Giraffe cranes are the unique equipment specially made for load-handling operations on warehouses and depots.

All mechanisms of the crane are frequency controlled.

Strengthened portal base of the crane-loader gives a possibility to install it over the railway, the unique engineering solutions let to reach maximal lifting capacity on the whole jib length.



PORTAL CRANE
TDKP-10.300

Maximal lifting capacity, t	10
Maximal jib radius, m	30
Lifting capacity at maximal jib radius, t	10
Maximal lifting height, m	23,8



PORTAL CRANE
TDKP-12,5.440

Maximal lifting capacity, t	12,5
Maximal jib radius, m	35
Lifting capacity at maximal jib radius, t	12,5
Maximal lifting height, m	15



NEW PRODUCTS

Giraffe engineering office works continuously on improvement.

We are working actively not only on the improvement of characteristics and development of new implementation of our serial cranes, but also on the extension of our model range.



In the near future, we launch serial production:

TOP-SLEWING
TOWER CRANE WITH CAT-HEAD
TDK-40.1250

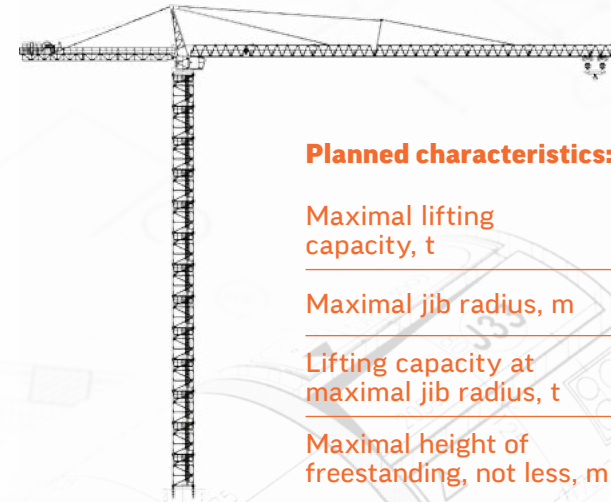

Planned characteristics:

Maximal lifting capacity, t	40
Maximal jib radius, m	80
Lifting capacity at maximal jib radius, t	10
Maximal height of freestanding, not less, m	80

TOP-SLEWING
TOWER CRANE
TDK-16.350

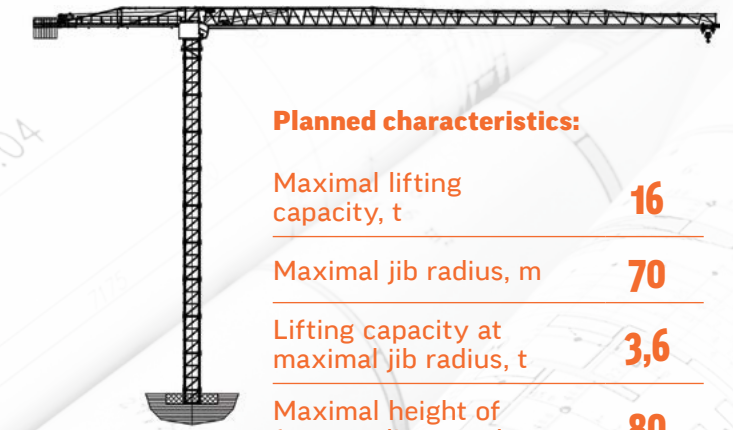

Planned characteristics:

Maximal lifting capacity, t	16
Maximal jib radius, m	70
Lifting capacity at maximal jib radius, t	3,6
Maximal height of freestanding, not less, m	80

NEW TOWER CRANE FOUNDATION

The **GIRAFFE** engineering office is designing cross frame element that doesn't need ballast units.

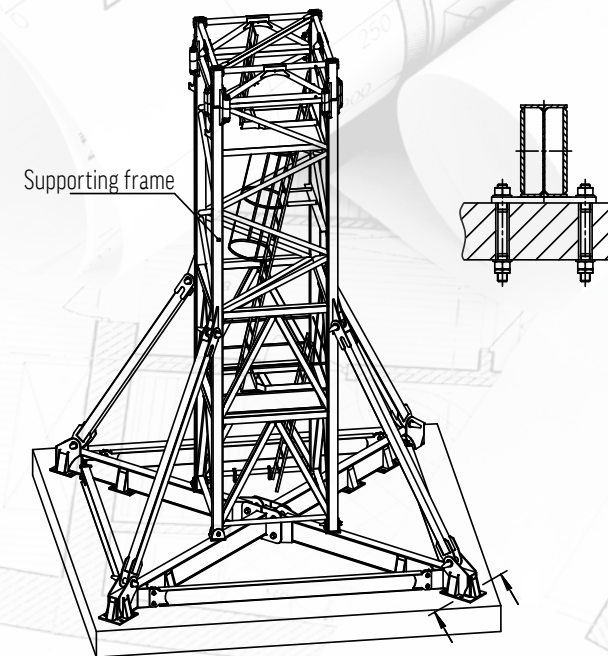

Our production capacity and wide experience of engineers produce a synergy effect to elaborate and to put the project of lifting equipment of any complexity into life at the earliest possible date.

You can always contact us, if you have questions about the improvement of existing models or the custom-built equipment's design.

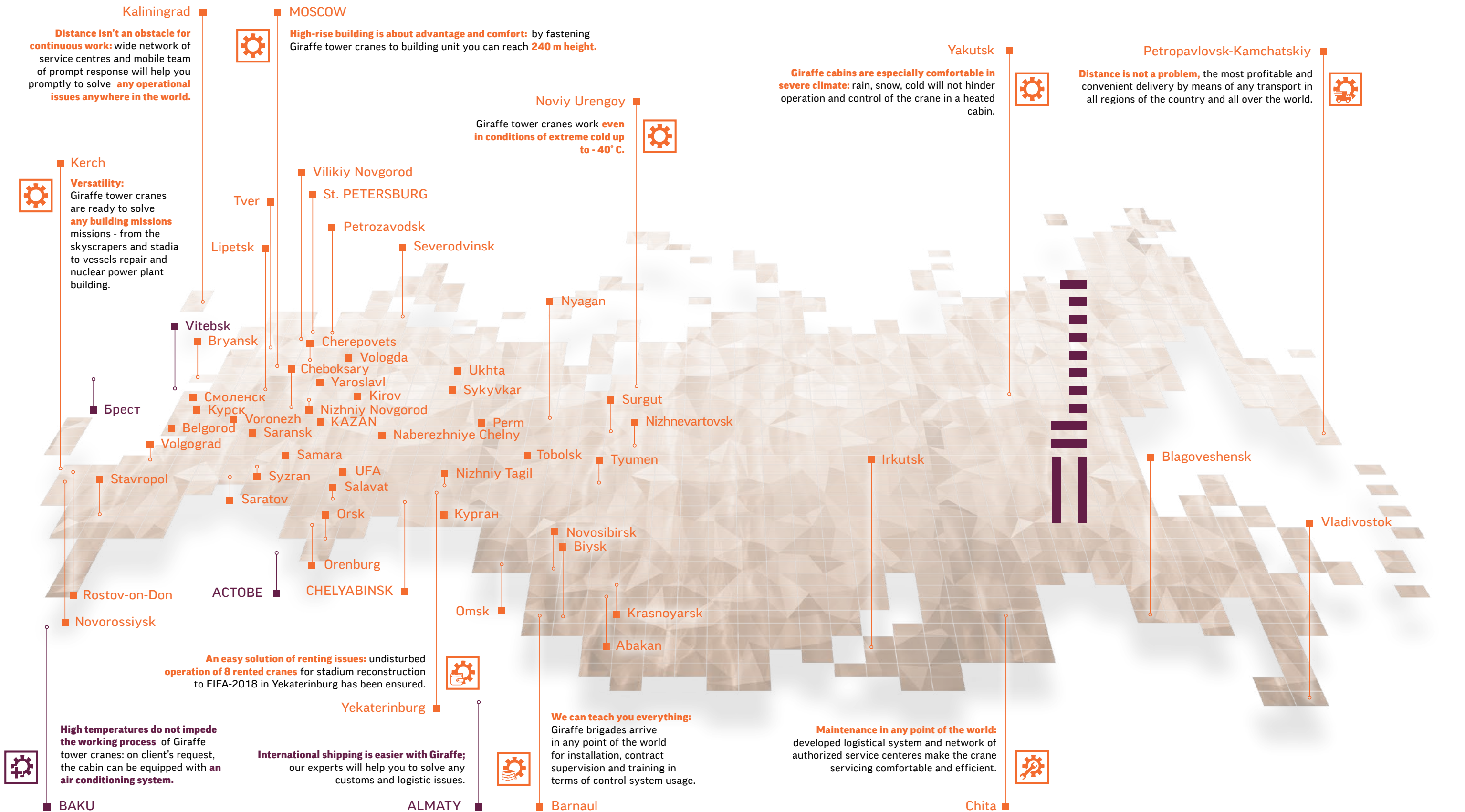

Giraffe means responsibility and European service!

over **100** cities

more than 1000 building units all over Russia



We are proud of our participation in realization of millions football fans' dreams all over the world.



STADIA

Giraffe cranes have been used in building of Kazan-Arena to Universiade; now they are used in the building and renovation of stadia to FIFA-2018 in **Volgograd, Ekaterinburg, Nizhny Novgorod, Saransk and Kaliningrad.**



GIRAFFE FOR SHIPBUILDING

Giraffe tower cranes are actively used in domestic shipbuilding: two tower cranes SMK-10.200 are in repair and reconstruction of the cruiser Admiral Nakhimov, and the tower cranes of TDK-type are actively used in building and remodelling of dockyards.

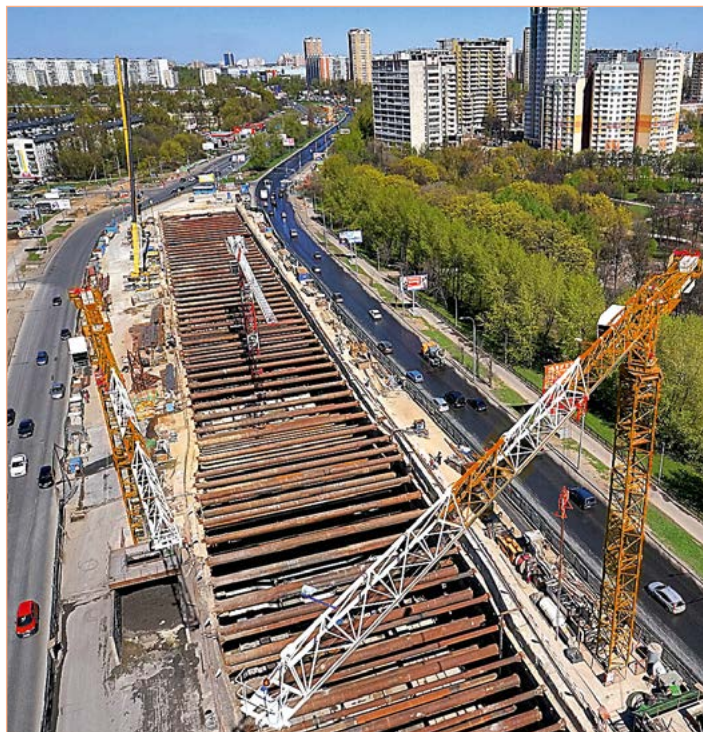

METROSTROY

The main Moscow project is the development program of underground railway. Tower cranes of TDK- and SMK-types are also presented at numerous housing and industrial projects of the capital and Moscow region.



THE NUCLEAR POWER STATION KURSK

Every year Giraffe tower cranes become winners of tenders for delivery of lifting equipment for units playing strategic role.

2015 Giraffe cranes begin to build objects of nuclear power station Kursk.



Giraffe has solid experience creating individual solutions for building of special units.

Federal Agency for Special Construction of Russia highly valued Giraffe cranes.

SKOLKOVO

Giraffe not only innovates new products, mechanisms and systems in crane production, but also helps to master innovations of other Russian organizations. Since 2015, Giraffe tower cranes works on the construction site of Skolkovo innovation center.





CIVIL ENGINEERING

Chelyabinsk

In Chelyabinsk Giraffe tower cranes become at once the key machinery in building new houses in several areas of the city, with the floor area over 150 hectare. New housing estates with developed and well-organized infrastructure have already become a home for thousands of happy families.



Samara

In Samara city tower cranes TDK-10.215 are used in building of luxury housing estates, from the windows of which picturesque views of the river Volga will be opened.



Kirov

Most building companies of the city use tower cranes SMK-10.200.

Twenty-storey city high-rise buildings are actively built with the help of TDK cranes.



Voronezh

Voronezh biggest builder is a regular GIRAFFE cranes client, which builds about 40% of urban housing. The key projects in the city are residential complexes 'Five stars', 'Olympiiskii', 'Cheluskincev, 101' and others, built by TDK-10.215 cranes.

Kazan

Here you won't find any building projects, where our new cranes haven't taken part: **the 2013 Universiade venues, football station KAZAN-ARENA, Palace of water sports, Volleyball Centre, Centre of shooting sports** satellite town – **Innopolis, residential complexes Salavat Kupere, Pobeda, Grand Park, Verbnii** and many others.



The whole territory of Russia is covered with jibs of our cranes.



Chita



Cheboksary



Novosibirsk



454048 CHELYABINSK, UL. ZAGORODNAYA, DOM 18, OFFICE 5
+7 351 729-92-93



WWW.GIRAFFECRANE.RU