

ELECTROMECHANICAL LOCK

Promix-SM203

OPERATING MANUAL

Technical description. Installation manual. Certificate.

ПШБА.304268.201 PЭ

PATENT FOR INVENTION

No.2420640

1. PURPOSE

Electromechanical locks series Promix-SM203 with a locking mechanism based on a skewed bar (below called the locks) are intended for locking swing doors, gates and wickets opening both inward and outward, which can be opened remotely by energizing/de-energizing (depending on the version) the lock with DC supply voltage by means of switches (buttons) or controllers of access monitoring and control systems, audio and video intercoms, code panels or other devices. The lock design and mounting method allow them to be installed inside or outside the protected premises on practically any door types.

2. LABELING

The label stuck to the lock body contains the following information:

1. Lock model.
2. Patent number.
3. Nominal supply voltage.
4. Nominal consumed current.
5. Date of manufacture and QCD mark
6. Identification number.
7. Manufacturer's website.

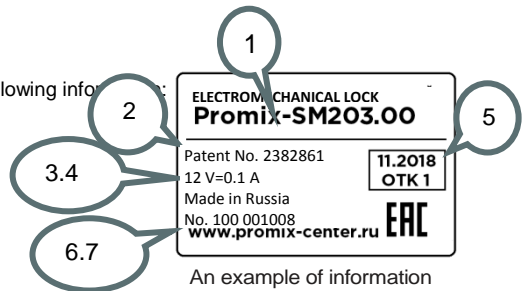

An example of information layout on the label.

Promix-SM203.XX.X

Availability of built-in sensors:
0(Absence) - no sensors. 3 – lock state sensors
 Supply voltage:
0 - 12V. 1 -24V
 Version:
 0 - normally opened, 1 - normally closed

For the list of lock modifications that can be ordered, see 5.2.

3. SET OF DELIVERY

1 – Lock	1 pc.
2 – Locking plate	1 pc.
3 – Self-tapping screw 3.5x32	2 pcs.
4 – Self-tapping screw 3.9x32	2 pcs.
5 - Marking template	1 pc.
6 – Operating manual	1 pc.

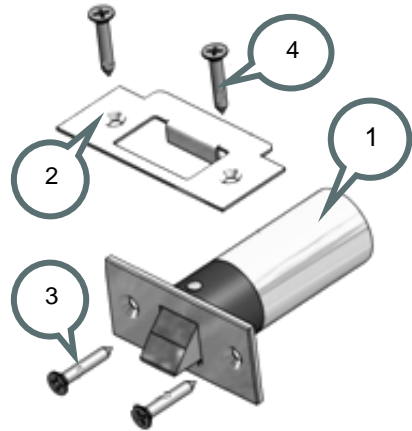

Check completeness of the lock set when buying! After buying, the manufacturer will not accept claims related to incomplete set.

4. DESIGN AND PRINCIPLE OF OPERATION

The locks are produced in two versions: normally opened (NO), and normally closed (NC). NO lock is in the open state when de-energized and in the closed state when voltage is supplied. NC lock is in the closed state when no voltage is supplied, and in the open state when the lock is energized. For opening the door, it is necessary first to de-energize a normally open lock or to supply voltage to a normally closed lock; only after that the door can be opened.

Depending on modification, a NO lock may be provided with a lock state sensor. The built-in lock state sensor consists of a magnetically controlled sensor (sealed-contact reed relay) mounted on the lock body, and a magnet mounted on the mobile sleeve of the lock. The reed contacts open when the catch is blocked (the lock is closed) and close when the catch is deblocked (the lock is open). The sensor is located on the rear side of the lock and is fastened by means of a plate.

The sensor is in an uncertain state (open or closed):
1) during the catch sinking into the lock (during door closing or opening);
2) in case of the absence of the necessary clearance between the catch and the locking plate (since the catch is partially inserted in the body).

The lock Promix-SM203 has a genuine mechanism of the catch “folding” into the lock body during opening the door.



- During closing the door (regardless of the lock version and the presence of voltage), the catch is sunk into the lock body just like an ordinary mechanical door catch.
- As voltage is supplied (for NO lock) or voltage is removed (for NC lock), the lock catch is blocked and does not permit the door opening.
- As voltage is removed (for NO lock) or supplied (for NC lock), the lock catch is deblocked and, as the door is opened, is “folded” into the lock body.

5. TECHNICAL DATA

5.1 OPERATING CONDITIONS

The lock operation environment must be explosion-safe, free of current-conducting dust or gases that cause metal corrosion and destroying insulation of current conductors and electric elements, free of current-carrying dust or water vapor, and preventing ingress of water, steam, fuel and lubricants.

Climatic conditions of operation – Y3.1 as per GOST 15150-69 with extended temperature range:

- ambient temperature: from -30 to +50 °C;
- Relative air humidity: not higher than 98% at 25°C or lower temperatures without moisture condensation and hoar-frost formation;
- installation indoors or outdoors excluding ingress of moisture, dust, dirt, etc. inside the lock.

5.2 TECHNICAL DATA

Modification	Promix-SM203.00	Promix-SM203.00.2	Promix-SM203.01.2	Promix-SM203.01
Version	normally opened			
DC supply voltage U, V	12±2		24±2	
Current consumed, A	85 (at 12V)		35 (at 24V)	
Supply pulse duration (not more than), s	not rated.			
Minimum pause between pulses, s	not rated.			
Built-in sensors	-	lock state sensor		-
Maximum switch current of the sensor (DC), A:	-	0.5		-
Maximum switch voltage of the sensor (DC), V:	-	36		-
Sensor output signal type	-	“dry contact”		-
Holding force (not less than), kg	300			
Lock weight (not more than), kg	0.19			
Power wire length, m	0.1			

[Promix-SM203](#)

Modification	Promix-SM203.10	Promix-SM203.10.2	Promix-SM203.11.2	Promix-SM203.11
Version	normally closed			
DC supply voltage U, V	12±2		24±2	
Current consumed, A	160 (at 12V)		75 (at 24V)	
Supply pulse duration (not more than), s	120 (at 11-14V)		120 (at 23-26V)	
Minimum pause between pulses, s	120			
Built-in sensors	-	lock state sensor		-
Maximum switch current of the sensor (DC), A:	-	0.5		-
Maximum switch voltage of the sensor (DC), V:	-	36		-
Sensor output signal type	-	"dry contact"		-
Holding force (not less than), kg	300			
Lock weight (not more than), kg	0.19			
Power wire length, m	0.1			

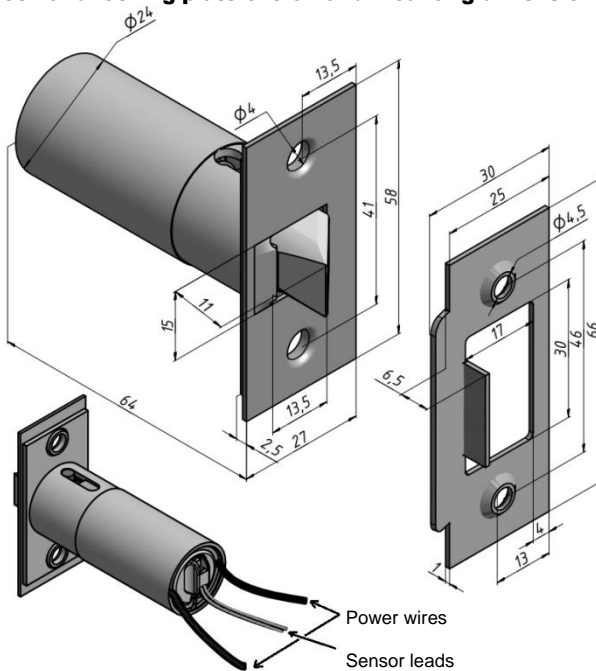
Lock and locking plate overall and mounting dimensions.

6. INSTALLATION AND CONNECTION

6.1 LOCK MOUNTING

The lock design allows mounting it in the door frame or in the door leaf.

During mounting, a clearance of 1-4 mm must be provided between the locking plate and the fastening plate of the lock. Meeting this condition guarantees a door holding force of 300 kg and a smooth operation of the door without wedging up.

It is necessary to provide a clearance between the catch and the locking plate in the closed state of the door.

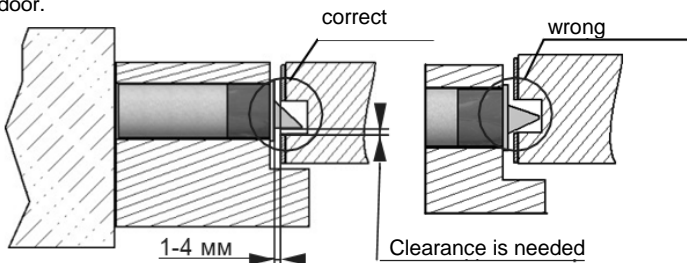

The lock mounting together with the locking plate included in the delivered set is OBLIGATORY! This will provide smooth operation and extend the lock service life.

Example of the lock installation in the door frame of a wooden door.

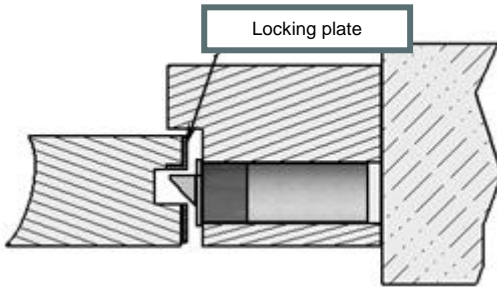
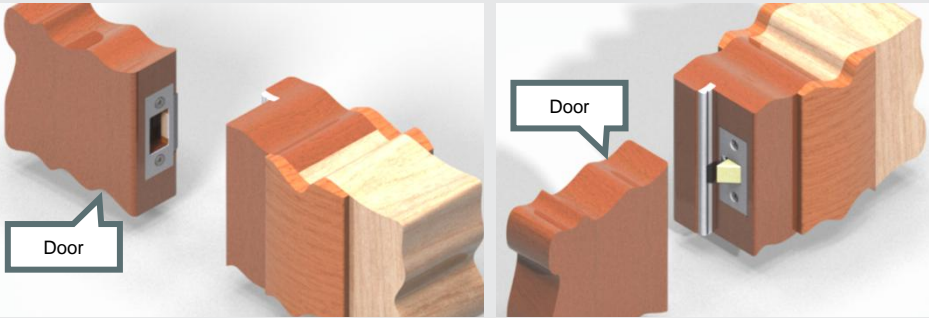

Example of the lock installation in the leaf of a metal door.

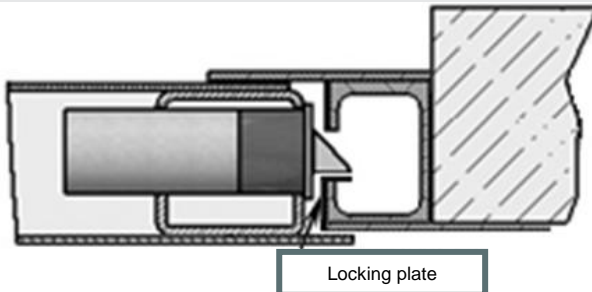
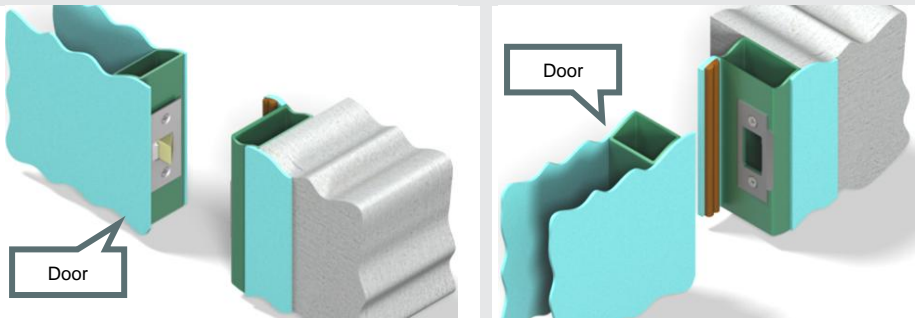

Example of the lock installation in the door frame of a plastic door.

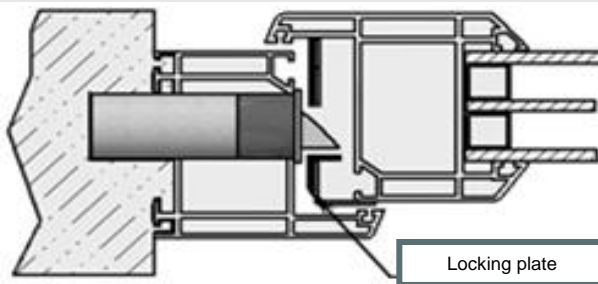

Example of the lock installation in the leaf of a wooden door.

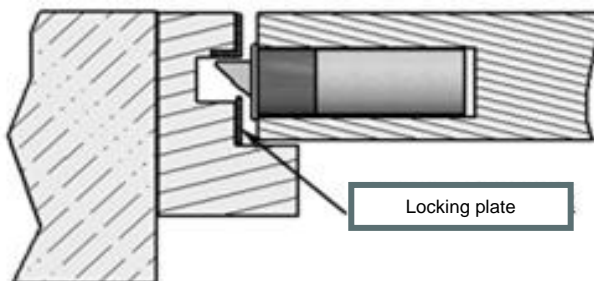

For marking the fastening holes for the lack installation in the door frame, a paper template included in the delivered set is used.

The template consists of two sides: on side for marking fastening holes of the locking plate on the door leaf, and the other side for marking fastening holes and the lock mounting slot on the door frame.

Lock installation in the door frame of a wooden door.

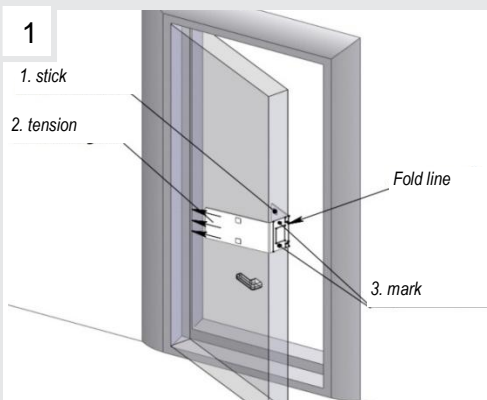

1. Remove protective film from the adhesive tape 1 of the template.
2. Bring into coincidence the door leaf edge nearest to the door frame and the template fold line.
3. Fix the template by sticking it to the door surface.
4. Using an awl, mark slot dimensions and centers of fastening holes of the locking plate.

2

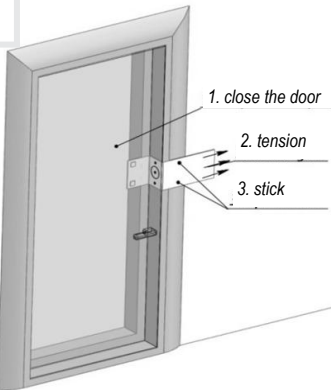

5. Shut the door. Remove protective film from the adhesive tape **2** of the template.
6. Tauten the template, fold and stick to the door frame.

3

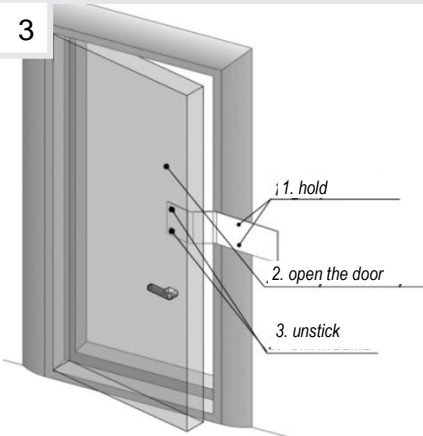

7. Holding the template at places of sticking to the door frame, open the door carefully and unstick the template from the door leaf. Eliminate the template displacement relative to the door frame.

4

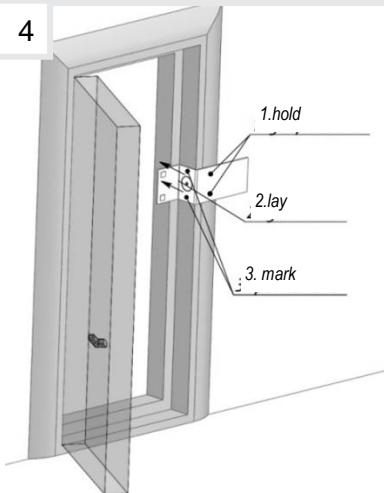

8. Lay the template on the door frame and mark fastening hole centers and the lock mounting slot with an awl.
9. Drill 2-2.5-mm diameter holes for self-tapping screws and 24-25-mm diameter holes for lock mounting.
10. Position the locking plate and the lock at their places and fix them with self-tapping screws included in the delivered set.
11. Remove white protective film from the locking plate and the lock.

6.2 CONNECTING PROCEDURE

The lock operation is controlled by means of energizing and de-energizing. For this purpose, a controller (control board) or a switch (button) is generally used. The controller is mounted in accordance with its certificate.

Connect the lock power wires adhering to the following polarity:

Red (black with a red stripe) – positive pole of the power supply;

Black – negative pole of the power supply;

Application of voltage of reverse polarity does not provide the lock operability but does cause its failure.

See operating voltage range in 5.2. Avoid application of a higher voltage or excessive pulse duration.

Connect sensor leads:

Colored wires (yellow, green, etc.) – lock state sensor output.

Example of the lock connection to the remote control system Promix-RDS.

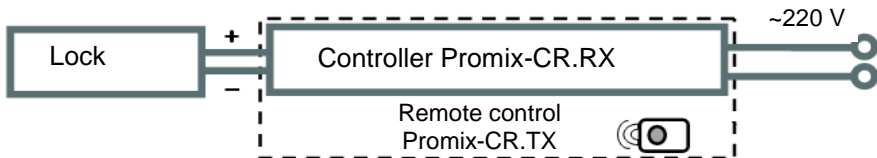

Provide a reliable electric contact. To prevent short-circuit, insulate places of connection.

7. SPECIAL ASPECTS OF INSTALLATION AND OPERATION

- 1) The possibility of using of the locks for restriction of access to the premises and the place of installation (outdoors or indoors) are determined by the **installation organization** on the basis of the design features and the mounting method, room criticality level, the purpose of the access restriction regime and other factors (the presence of security providers, video surveillance, etc.).
- 2) During mounting the lock and the locking plate, it is necessary to ensure their coaxial alignment within the catch free movement allowance.
- 3) A NO lock may be mounted outdoors on condition that in winter it is closed (energized) for most time. This prevents freezing of lubricant in the lock by virtue of heat released. **NC locks are not intended for outdoor installation.**
- 4) The properly mounted lock provides the necessary free motion (play) of the door. If the free play is absent, NC lock may **fail to open** when energized, and NO lock may **fail to close** when energized (see section 8).
- 5) Operation of an installed NC lock should be tested only if the supply voltage can be applied thereto.
- 6) When using NC lock for restriction of access to rooms or in evacuation routes. Mounting of the lock deblocking mechanism Promix-AD.KM.01 (delivered separately) is obligatory, since it is necessary to provide exit for people in case of an emergency (e.g., fire).

8. TROUBLE-SHOOTING

Troubles and problems	Remedies
<p>NC lock does not open when supply voltage is applied.</p> <p>NO lock does not close when supply voltage is applied.</p>	<p>Using a tester, check integrity of the lock power circuit.</p> <p>Check polarity and conformity of the lock supply voltage to the required value.</p> <p>Check the presence of the required clearances (see section 6).</p>
<p>The lock closes with difficulty, the catch does not operate smoothly.</p>	<p>Check the presence of the required clearances (see section 6).</p> <p>Check whether the locking plate and the fastening plate are skewed, if necessary, remove skewing.</p> <p>In case of strong rubbing of the catch against the locking plate, lubricate the places of contact with grease (SHRUS).</p>
<p>The door has sunk during operation, therefore, the catch does not enter the opening in the locking plate.</p>	<p>Restore the door position. If this is impossible, remove the locking plate from the door. Fasten the locking plate to the door providing the required clearances.</p>
<p>NC lock does not close when supply voltage is applied.</p> <p>NO lock does not open when supply voltage is applied.</p>	<p>Check the presence of required clearances between the catch and the locking plate (see section 6)</p>

9. MAINTENANCE

The lock Promix-SM203 is lubricated by the manufacturer and does not need additional lubrication or any special maintenance. However, if dust or dirt penetrated inside the lock during service, and the lock began to show malfunction, then dismantle the lock, unstick the protective film carefully (grey vinyl film covering slots of the body). Wash the lock immersing it in white spirit or petroleum solvent with the catch downwards, to a depth of the thinned portion of the body (not deeper!).

Dry the lock and make sure that its operability has restored. Lubricate inner walls of the body and slot ends through the slots, without sinking the catch; use a water-resistant, antifriction plastic grease (e.g., SHRUS).

Then sink the catch and lubricate inner walls of the body on the side of the catch. Replace the protective film removed earlier, and mount the lock on the door.

It is prohibited to use silicone grease and WD-40.

10. STORAGE AND TRANSPORTATION

Until putting into operation, the locks must be stored in the manufacturer's packing, in rooms with an ambient temperature of -30 to +50 °C and a relative humidity not higher than 98% at 25° C in compliance with storage conditions as per GOST 15150-69.

Locks transportation conditions must comply with group C as per GOST 23216-78 in terms of exposure to mechanical factors, and Ж2 as per GOST 15150-69 in terms of exposure to climatic factors.

11. SAFETY REQUIREMENTS

The design of the locks ensures safety of personnel involved in mounting and maintenance.

Due to low DC supply voltage, the products correspond to class III as per ГОСТ 12.2.007.0-75 and are electrically safe.

Fire safety of the locks is ensured by use of non-combustible or hardly combustible materials, and low supply voltage.

12. DISPOSAL

The product is not hazardous for human life and health or for the environment; disposal after its service life is performed without taking any special measures for environment protection.

13. WARRANTY LIABILITIES

The manufacturer, ETC PROMIX LLC, warrants conformity of Promix-SM203 locks to requirements of current Technical Specifications provided that transportation, storage, installation and operation rules established in this Manual are followed.

The warranted operation period is 12 months from the date of sale but not longer than 18 months from the day of acceptance by the manufacturer's QCD.

Within the period of warranty, ETC PROMIX LLC undertakes to repair defective products free of charge. Expenses for transporting the product to the place of repair and back will be borne by the Buyer.

Warranty liabilities do not cover any defects and damages caused by:

- Improper maintenance by the Buyer;
- Use of the product under conditions that do not comply with the operation requirements;
- Mechanical damages or disassembly of the products by the Buyer;
- Non-observance of the transportation and storage rules.

Faulty products are accepted for repair only together with the latch, on the obligatory condition that factory labels are retained on the product body.

On expiration of the warranty service period, the manufacturer provides after-warranty service on a contractual basis.

To improve product quality the manufacturing plant reserves the right to make modifications to the product design without prior notice.

14. ACCEPTANCE AND PACKING CERTIFICATE

Electromechanical lock Promix-SM203 in quantity of ____ pieces (1 pc. by default) bearing the manufacturing date and QCD mark on the body, was manufactured and accepted in compliance with Specifications ПШБА.304268.002 ТУ, obligatory requirements of state standards and current technical documentation, recognized as fit for operation and packed by ETC PROMIX LLC.